

# SUITE STOOL

**COD. 900**

## Stool on wheels

Specially designed stools for the beauty sector, ideal for guaranteeing the maximum comfort of professionals who perform manicures, pedicures and aesthetic facial treatments. The stools come complete with a gas-pump height adjustment.

## Sgabello con ruote

Sgabelli appositamente progettati per il settore beauty, ideali per garantire il massimo comfort ai professionisti che eseguono manicure, pedicure e trattamenti estetici del viso. Gli sgabelli sono completi di regolazione dell'altezza tramite pompa a gas.



## SUITE STOOL – Dimensions / Dimensioni

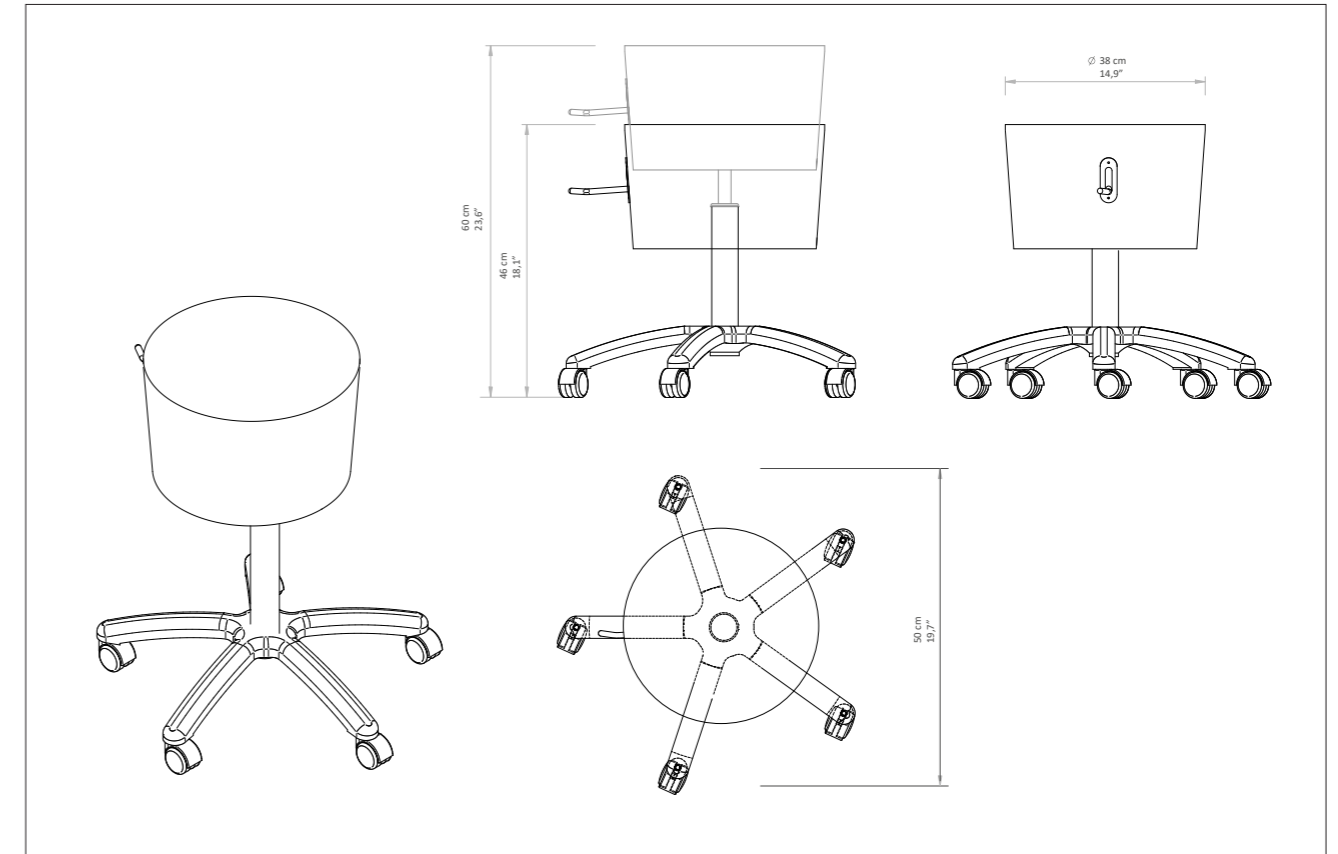

## SUITE STOOL – Technical Requirements / Caratteristiche tecniche

Height / Altezza	Diameter / Diametro	Warranty / Garanzia
Height min - 46 cm 18,1" Height max - 60 cm 23,6"	Base Ø - 41 cm 16,1" Seat Ø - 38 cm 14,9"	Structure and gaslift adjustment: 2 years Undeformable foam: 5 years
Altezza min - 46 cm Altezza max - 60 cm	Base Ø - 41 cm Seduta Ø - 38 cm	Struttura e regolazione gaslift: 2 anni Gomma indeformabile: 5 anni

## INCLUDED

Wheels/ Ruote

Aluminium base Ø50 cm / 19,6" / Base alluminio Ø50 cm

## SEAT FINISH AVAILABLE WITH



Capitoné padding / Imbottitura capitonné  
Smooth padding / Imbottitura liscia

# SUITE STOOL

**COD. 835**

*Stool on wheels with backrest*

*Specially designed stools for the beauty sector, ideal for guaranteeing the maximum comfort of professionals who perform manicures, pedicures and aesthetic facial treatments. The stools come complete with a gas-pump height adjustment.*

*Sgabello con ruote e schienale*

Sgabelli appositamente progettati per il settore beauty, ideali per garantire il massimo comfort ai professionisti che eseguono manicure, pedicure e trattamenti estetici del viso. Gli sgabelli sono completi di regolazione dell'altezza tramite pompa a gas.



## SUITE STOOL – Dimensions / Dimensioni

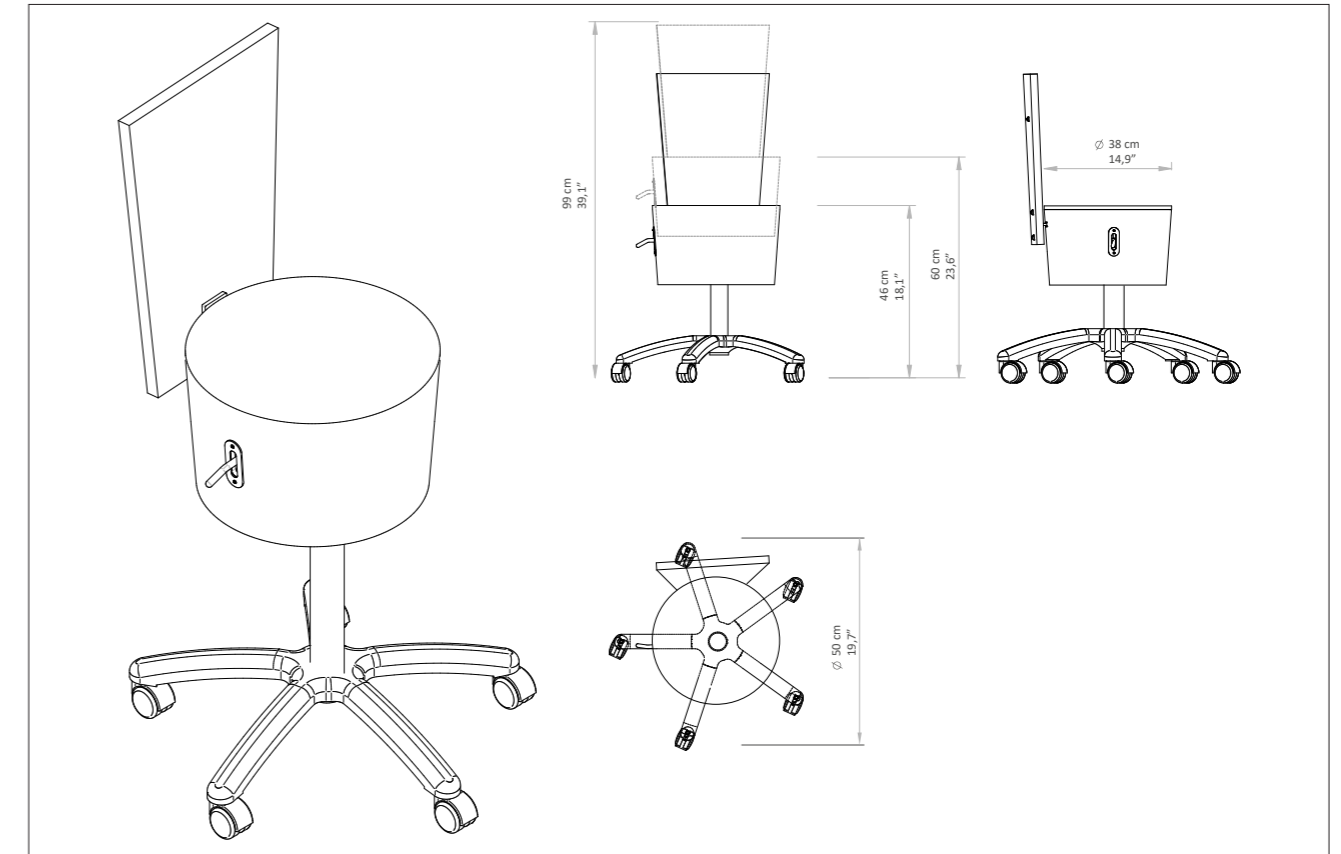

## SUITE STOOL – Technical Requirements / Caratteristiche tecniche

Height / Altezza	Diameter / Diametro	Warranty / Garanzia
Height min - 46 cm 18,1" Height max - 60 cm 23,6"	Base Ø - 41 cm 16,1" Seat Ø - 38 cm 14,9"	Structure and gaslift adjustment: 2 years Undeformable foam: 5 years
Altezza min - 46 cm Altezza max - 60 cm	Base Ø - 41 cm Seduta Ø - 38 cm	Struttura e regolazione gaslift: 2 anni Gomma indeformabile: 5 anni

### INCLUDED

Backrest / Schienale

Wheels/ Ruote

Aluminium base Ø50 cm / 19,6" / Base alluminio Ø50 cm

### SEAT FINISH AVAILABLE WITH



Capitonné padding / Imbottitura capitonné  
Smooth padding / Imbottitura liscia

# MATTRESS CUSTOMIZATION PERSONALIZZAZIONE MATERASSO

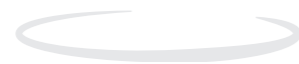

## VITA - COLOR CHART

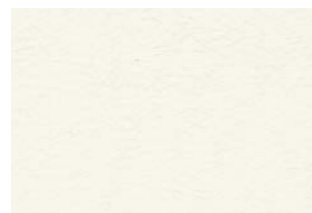

EV00021



EV00022



EV00041



EV00042

## SPA PRESTIGE - COLOR CHART



9916

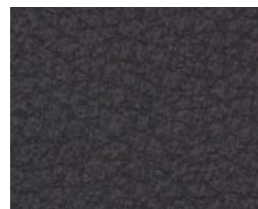

1424

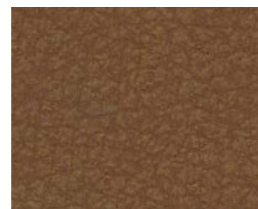

1423

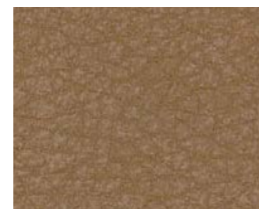

1422

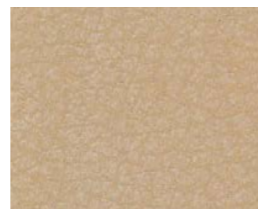

2202



2204



7022



7023

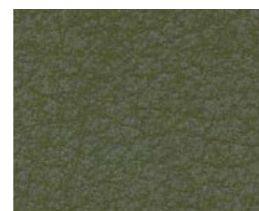

1875

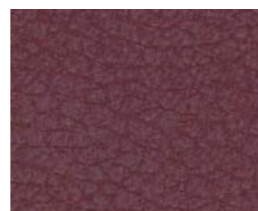

1530

## NEFOS - COLOR CHART

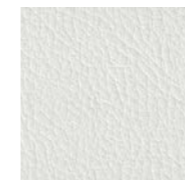

6



1957



6985



3962

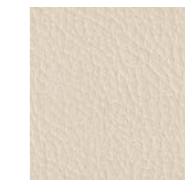

1155

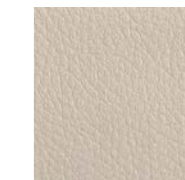

2124



1194



2173



6986



569

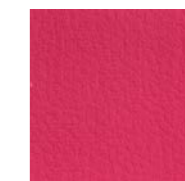

667



680



64



71

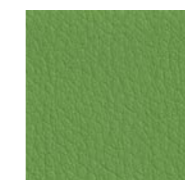

1868



1843

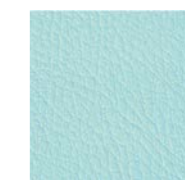

8019

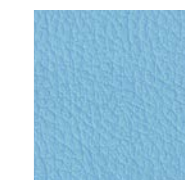

8009



5946



6940



6941



6942



1388

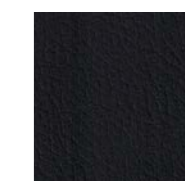

991

The innovative VITA (consisting of 80% natural and renewable components), Spa Prestige and Nefos materials - which are exclusive for LEMI products - and their special finishing touch guarantee easy-cleaning and hygiene. Their extraordinary structural qualities will persist through the years. An incredibly elastic texture enhances the memory foam mattress softness and quality at its best, giving Spa Clients a complete and satisfying wellness experience.

Gli innovativi materiali VITA (costituiti per l'80% da componenti naturali e rinnovabili), Spa Prestige e Nefos - che sono un'esclusiva dei prodotti LEMI - ed il loro speciale tocco di finitura garantiscono una facile pulizia e igiene. Le loro straordinarie qualità strutturali permangono nel corso degli anni. Una texture incredibilmente elastica migliora al massimo la morbidezza e la qualità del materasso in Memory Foam, dando ai clienti Spa un'esperienza di benessere completa e soddisfacente.

The images are for illustrative purposes only and may not reflect the actual finish of the product, particularly when viewed through a screen. Therefore, the **SELECTION OF THE FINISHES** of the **MATTRESS FABRICS** must take place **AFTER CONSULTING** the **PHYSICAL SAMPLES** of the **COLOR CHARTS**.

Le immagini hanno valore puramente illustrativo e possono non rispecchiare la finitura reale del prodotto, in particolare se visualizzate attraverso uno schermo. Pertanto la **SELEZIONE DEI RIVESTIMENTI** dei **MATERASSI** deve avvenire **PREVIA CONSULTAZIONE** della **CAMPIONATURA FISICA** delle **CARTELLE COLORI**.

# BACKREST CUSTOMIZATION PERSONALIZZAZIONE SCHIENALE



Today, 70% of the company's wooden equipment and treatment tables are manufactured using FSC certified lumber from unprotected forests. The woods are furnished by suppliers that have committed themselves to sustainable development, guaranteeing full compliance with the best environmental protection practices.

Oggi, il 70% delle attrezzature e dei lettini in legno dell'azienda sono realizzati con legname certificato FSC proveniente da foreste non protette. I legni provengono da fornitori che si sono impegnati per lo sviluppo sostenibile, garantendo il pieno rispetto delle migliori pratiche di tutela ambientale.

The images are for illustrative purposes only and may not reflect the actual finish of the product, particularly when viewed through a screen. Therefore, the **SELECTION OF THE FINISHES** of the **BASES** and **MATTRESS FABRICS** must take place **AFTER CONSULTING** the **LUXURY BOX PHYSICAL SAMPLES** and the **COLOR CHARTS**.

Le immagini hanno valore puramente illustrativo e possono non rispecchiare la finitura reale del prodotto, in particolare se visualizzate attraverso uno schermo. Pertanto la **SELEZIONE DELLE FINITURE** delle **BASI** e dei **RIVESTIMENTI** dei **MATERASSI** deve avvenire **PREVIA CONSULTAZIONE** della **CAMPIONATURA FISICA** della **LUXURY BOX** e delle **CARTELLE COLORI**.

## REGULATIONS

All Equipment is **CE** marked

## NORME

Tutte le attrezzature sono a marchio **CE**

**Lemi**  
ITALIAN WELLNESS EQUIPMENT

**Brusaferrì & C srl**  
Via Mara Maretti Soldi, 13  
26011 Casalbuttano (CREMONA) ITALY  
Phone +39-0374-363069 Fax +39-0374-363071  
info@lemigroup.it service@lemigroup.it

[www.lemigroup.it](http://www.lemigroup.it)